

Unleash your  
**Creativity**



**Hisense** | COMMERCIAL  
DISPLAY

**GoBoard Live GoBoard Pro GoBoard**

Advanced Interactive Displays

## GoBoard Live

Advanced Interactive Display with Integrated 4K Camera



**MR6DE**  
65" | 75" | 86"

## GoBoard Pro

Advanced Interactive Display



**MR6IDE-E**  
65" | 75" | 86"

## GoBoard

Advanced Interactive Display



**MR6DE-E**  
65" | 75" | 86"



### Introducing the latest generation of Advanced Interactive Displays

Hisense Interactive Display solutions deliver unrivalled performance and market leading value. Combining the power of a digital display, tablet, electronic whiteboard and video conference device, Hisense delivers the ultimate all-in-one display solution. Superior processors and the latest touch technology provide best-in-class user experiences while seamless wireless integration makes collaboration both simple and engaging. The NEW GoBoard and GoBoard Live displays features Google Certification and Android 13 operating system.

### Native Apps

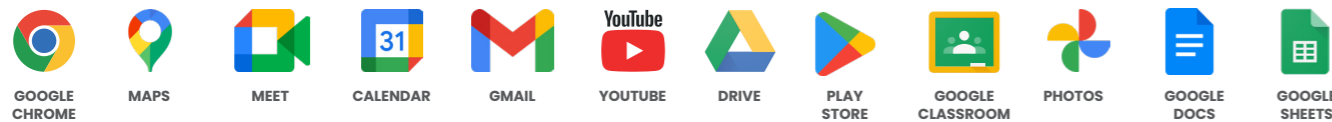

### EDLA Google Certification

EDLA certification enables Google Mobile Service users to easily install apps with the Google Play™ store on their Hisense display. Admins can also manage app installations and enjoy out-of-the-box access to Google Drive and YouTube, plus easy access to Google Classroom, Docs, Slides, and Sheets. The GoBoard and GoBoard Live will also now leverage the latest Android 13 security enhancements including additional protections against app vulnerabilities through Google Play Protect.



### 4K Ultra HD Panel / 4K UI

The 4K Ultra HD picture quality ensures perfect colour and rich details in all possible surroundings. In addition to the 4K screen as always, we bring a 4K user interface for the GoBoard. With the 4K UI, we can use this clear and bright screen to provide the most beautiful imagery.



### Smart Power

A built-in ambient light sensor automatically adjusts the screen brightness according to current light conditions. This display is Energy Star certified to help you protect the environment and save costs.



### Smart whiteboard

GoBoard uses high-level touch to restore natural writing habits by enabling pen tip writing, cap erasing, finger moving objects and palm erasing, while also providing teachers and students with a wide range of teaching tools such as protractors, triangles and rulers.



### Wireless transmission

GoBoard supports Webcast, Miracast, Dongle Transfer, Hisenseshare, etc. Dual WiFi modules simultaneously support a screen-sharing hotspot and Wi-Fi network connection. With low image latency, you'll enjoy a faster, more stable connection and a superb screen-sharing experience.



### Google Integration

With Google Education, GoBoard enables users to easily access Google applications such as Google Classroom, Google Chrome, Play Store, Gmail, Google Drive, Google Docs, etc. This helps teachers save time managing their classroom and assignments.



### Safer and Enhanced Experience

Android 13 works to keep your data safe and secure. With Android 13, you have more control over what information apps can and can't access. Devices that work better together, enhance your messaging, audio and multitasking experiences.



### Dolby Atmos

Movies, TV shows, sports, music – the entertainment you love is even better when you hear it in Dolby Atmos. Its crystal clarity, easy-to-hear dialogue, great detail, and realistic surround-sound effects all come together to dial up the impact of your favourite scenes and events.



### Integrated 4K camera

The GoBoard Live has an integrated 4K camera is designed with a physical cover and a working light to ensure the privacy of attendees.

### MR6DE

Advanced Interactive Display with Integrated 4K Camera



65" | 75" | 86"

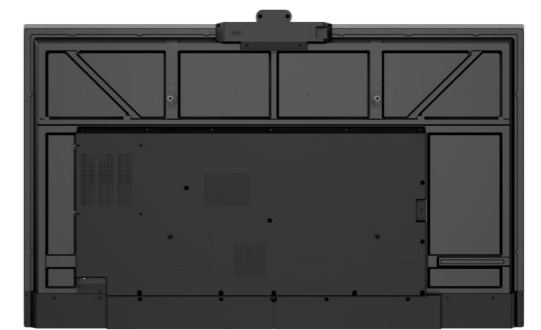

### MR6DE-E / MR6IDE-E

Advanced Interactive Display



65" | 75" | 86"

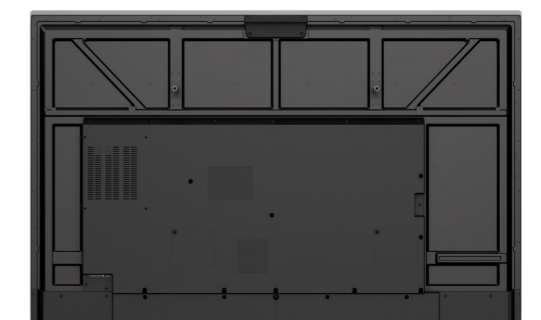



**4K Ultra HD Panel / 4K UI**

The 4K Ultra HD picture quality ensures perfect colour and rich details in all possible surroundings. In addition to the 4K screen as always, we bring a 4K user interface for the GoBoard. With the 4K UI, we can use this clear and bright screen to provide the most beautiful imagery. The AI upscaler analyzes each frame, adjusting the pixels to produce the best 4K image possible.

The GoBoard and GoBoard Live provide exceptional visual clarity, precise touch sensitivity, immersive collaboration, enhanced content creation, multi-user support, versatile applications, improved user engagement and high-quality media playback.

These advantages collectively make our 4K interactive display boards valuable tools for education, business, and creative endeavors, enhancing communication, collaboration, and interactivity in modern digital environments.



**Dolby Atmos**

Dolby Atmos is an advanced audio technology that delivers a three-dimensional sound experience, adding an extra dimension of realism and immersion to audio content. While Dolby Atmos is primarily known for its applications in home theaters and cinemas, integrating it into an interactive display board can offer many unique benefits.

Dolby Atmos can elevate the overall interactive experience, making it more engaging, impactful, and enjoyable for users in various contexts.

Movies, TV shows, sports, music – the entertainment you love is even better when you hear it in Dolby Atmos. Its crystal clarity, easy-to-hear dialogue, great detail, and realistic surround-sound effects all come together to dial up the impact of your favourite scenes and events.



**HDR10 Decoding**

GoBoard supports HDR10 Decoding. Whether you want to catch up on the latest content or simply enjoy some time with your favourite immersive games, this delivers original content with better detail in the shadows and brighter highlights.

HDR10 decoding enables displays to show a wider range of brightness levels, from deep blacks to bright highlights. This expanded dynamic range results in more realistic and lifelike images, as details in both dark and bright areas of the picture are preserved, creating a more immersive viewing experience.

HDR10 remains one of the most widely supported HDR formats in the industry, delivering an impressive improvement in picture quality and enhancing the overall viewing experience.



**Ambient light sensor**

A built-in light sensor automatically adjusts the screen brightness according to current light conditions.

The ambient light sensor ensures that the displays brightness and contrast levels are adjusted to match the lighting conditions in the room. In brightly lit environments, the display brightness will increase, providing better visibility and preventing the picture from appearing washed out. In dimly lit or dark rooms, the display brightness will decrease to avoid eye strain and create a more comfortable viewing experience.

One significant advantage of the ambient light sensor is its ability to enhance energy efficiency. In addition, this technology reduces eye strain and extends the displays lifespan whilst providing a consistently high picture quality.

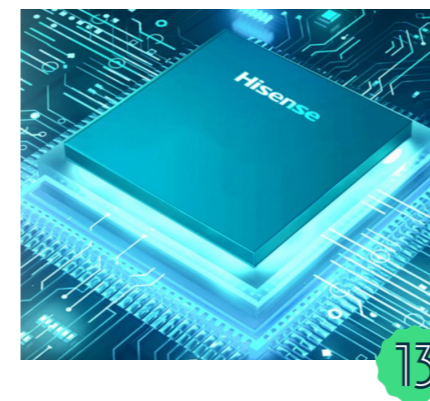

**Safer and Enhanced Experience**

Android 13 works to keep your data safe and secure. With Android 13, you have more control over what information apps can and can't access. Devices that work better together, enhance your messaging, audio and multitasking experiences. Expect unstoppable performance by an octa-core processor and 4+64GB memory.

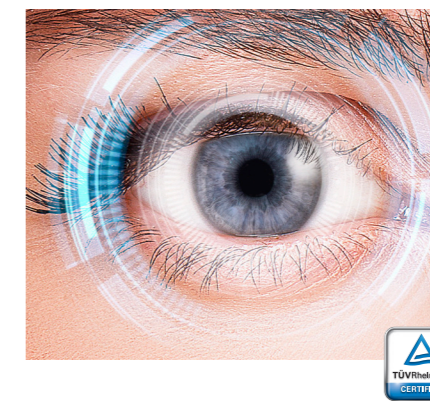

**Eye Comfort**

Certified by TÜV Rheinland, Hisense GoBoard has been proved to effectively minimize the harm and protect your eyes by reducing the blue light ratio. The GoBoard uses Flicker Free technology to ensure that users can view the screen for long periods of time without visual fatigue, while protecting their eyesight.



**Smart Power**

A built-in ambient light sensor automatically adjusts the screen brightness according to current light conditions. This display is Energy Star certified to help you protect the environment and save costs.

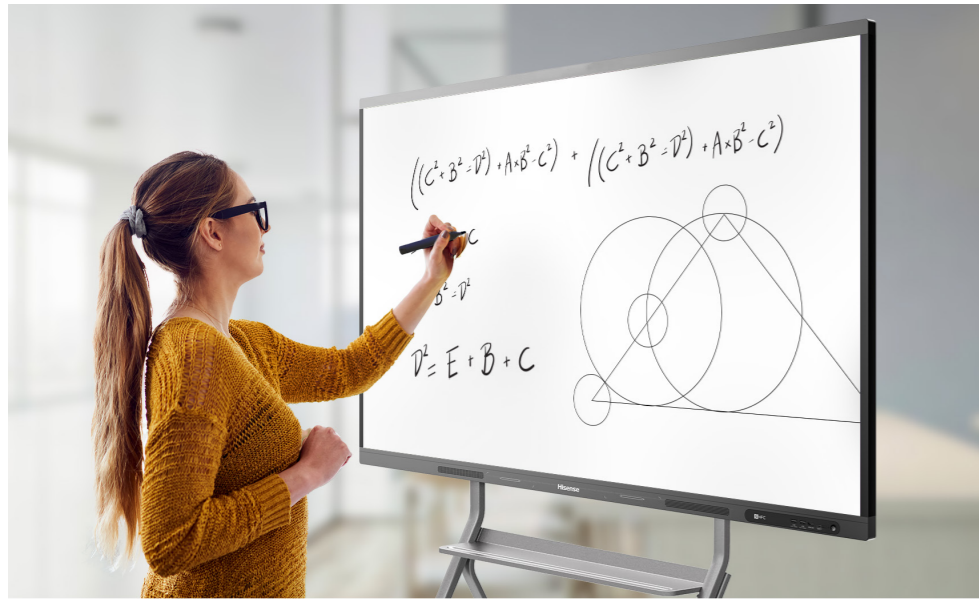

**Quatro Sense**

Digital whiteboards play a crucial role in transforming traditional classrooms into dynamic and interactive learning spaces. By leveraging technology and multimedia content, GoBoard has the potential to enhance student engagement, improve learning outcomes, and foster a more collaborative and inclusive educational experience.

GoBoard uses high-level touch to replicate natural writing habits by enabling pen tip writing, cap erasing, finger moving objects and palm erasing. GoBoard also provides a wide range of teaching tools such as protractors, triangles and rulers allowing educators and students to interact with content in a dynamic and engaging way.

**4K Camera**

4K cameras offer four times the resolution of standard HD cameras, resulting in sharper and more detailed video quality. This level of clarity allows participants to see facial expressions, body language, and shared content with greater precision, enhancing communication and understanding.

The GoBoard Live camera is designed with a physical cover and a working light to ensure the privacy of attendees.

**Array microphones**

GoBoard Live use 8 Array microphones and advanced beamforming technology to focus on the speaker and eliminate background noise. This results in clearer audio, reducing distractions and improving the overall meeting quality.

The array microphones can accurately detect and isolate the voice of the active speaker. This feature is to allows remote participants to hear the person speaking clearly, even in a large room with multiple speakers.



**Standard Word Transcription**

GoBoard allows smart handwriting, which can turn handwriting into standard characters automatically. No more worrying about bad handwriting, any letter, word, number, punctuation, can become standard. More beautiful to display and clearer to see.

The interactive nature of the GoBoard helps cater to different learning styles. Students who are visual learners can better grasp concepts when they are presented using digital content, while auditory learners benefit from interactive discussions and audio features.



**Smart Tools**

GoBoard is equipped with intelligent drawing recognition technology, which recognizes squares, circles, triangles, arrows and line segments.

In addition, you can draw a table on the screen and the table will adapt its size along with the touch-written content, while also providing teachers and students with a wide range of teaching tools such as protractors, triangles and rulers.

Multiple students can work together on the same board simultaneously, encouraging teamwork, discussion, and peer-to-peer learning. This fosters a more inclusive and participative classroom environment.



**GoBoard Live**



**Auto Framing**

Auto Framing technology automatically detects and frames all participants in the conference room. This can optimise the space and help your audience to stay engaged. This eliminates the need for manual adjustments or panning, ensuring that everyone in the room remains visible without someone having to operate the camera continuously.

Auto-framing cameras promote a more engaging and dynamic video conferencing experience. By focusing on the active speaker or participants, it keeps viewers' attention and reduces distractions caused by unnecessary background movements.

Auto-framing cameras can continuously adapt to different room sizes and configurations. Whether the conference room has a few participants or a larger group, the camera can intelligently adjust its framing to suit the situation.



### Easy Wireless Sharing

GoBoard supports Webcast, Miracast, Type-C dongle transfer and Hisense Share. Everything you need for screen sharing solutions. Hisense Share is a in house built-in screen sharing application that enables the screen sharing wirelessly and seamlessly from any devices, anytime, anywhere.



Dual WiFi modules simultaneously support a screen-sharing hotspot and Wi-Fi network connection. With low image latency, you'll enjoy a faster, more stable connection, and a superb screen-sharing experience.



### Benefits for Education and Corporate Environments

The GoBoard and GoBoard Live offer a range of benefits in education and corporate environments by promoting active learning, facilitating collaboration, and improving engagement and productivity. These versatile displays have become an essential part of modern learning and working spaces, fostering an interactive and inclusive environment that supports effective communication, knowledge sharing, and decision making.

## Specifications

### Interactive Display Panel

Models	65MR6DE / 75MR6DE / 86MR6DE
Backlight Type	D-LED
Resolution	3840x2160(pixels)
Brightness	350nits
Contrast Ratio	65"/75": 1200:1(typ.), 86" 4000:1(typ.)
Response Time	8ms (typ.)
Refreshing Frequency	60Hz
Viewing Angle	178° (H) / 178° (V)
Lifetime	50,000 hrs (min.)
Color Gamut(X% NTSC)	72%
Display Colors	1.07B(10bit)

### System

CPU	Architecture - ARM A73(4) +A53(4) Working Frequency - 2.2GHz + 2.0GHz
GPU	MaliG52
RAM	4GB
ROM	64GB
OS	Android 13.0
Language	Chinese, English, Polish, German, French, Italian, Spanish, Finnish, Norwegian, Swedish, Thai, Indonesian, Japanese

### Power

Power Requirements	AC 100 V ~ 240 V, 50/60 Hz
Power Consumption Without OPS	65":240W max. 75":350W max. 86":430W max.
Standby Consumption	<0.5W
Built In Speaker	2x15W+20W
OPS Power	DC 12V/5A

### Connectivity

Wi-Fi	IEEE 802.11a/b/g/n/ac/ax(2.4G and 5G) IEEE 802.11a/b/g/n/ac(2.4G and 5G)
Bluetooth	BT5.1
NFC	Yes
Camera	Yes
Input	HDMI (2.0) IN x3 OPS (Optional) x1 LAN x1 (1000baseT R) USB3.0 x3 Type-C x1 (Support PD 65W) Touch x1 Audio In x1 RS-232 In x1(RJ45)
Output	RS232 OUT x1 (RJ45) HDMI Out x1 S/PDIF Out x1 Audio Out x1

### Certification



Standard Certification	CB/CE/ERP/South Africa Efficiency/ TUVus/CEC/FCC/ICASA/Energy Star
------------------------	---

### Touch

Sensing Type	Infrared Touch Frame
Surface Protection	Anti-Glare Glass
Infrared Touch	≤20 points
Touch Accuracy	90%(±1mm)
Theory Clicks	Unlimited
Minimum Touch Object	≥2mm
Writing Height	<1.5mm (Support Four-Level Recognition)
Windows 10/8/7,Android	Multi Touch

### Dimensions

**65"** 1488<sup>W</sup> x 935<sup>H</sup> x 122<sup>D</sup> mm / 58.6 x 36.8 x 4.8 inch  
35 kg / 77.18 lbs

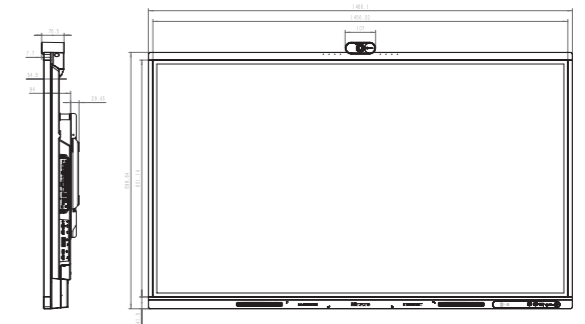

**75"** 1710<sup>W</sup> x 1060<sup>H</sup> x 126<sup>D</sup> mm / 67.3 x 41.7 x 5 inch  
45.8 kg / 100.99lbs

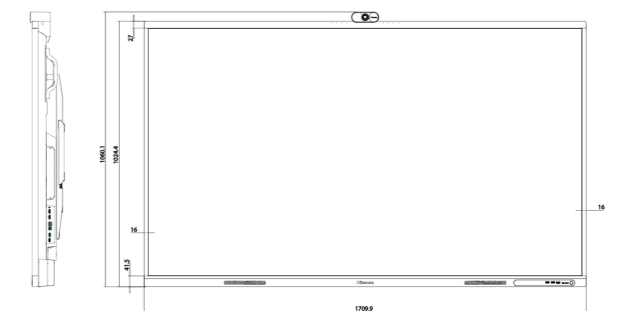

**86"** 1955<sup>W</sup> x 1198<sup>H</sup> x 126<sup>D</sup> mm / 77 x 47.2 x 5 inch  
58.5 kg / 127.89 lbs

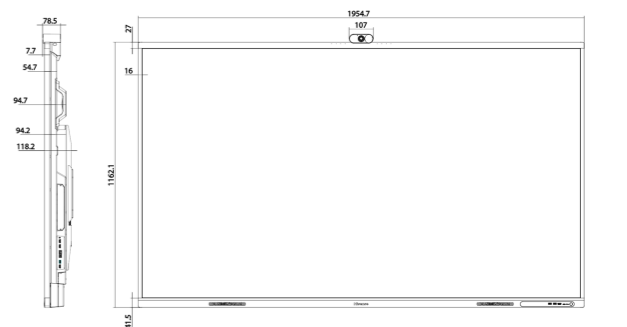

Interactive Display Panel

Models	65MR61DE-E / 75MR61DE-E / 86MR61DE-E
Backlight Type	D-LED
Resolution	3840x2160(pixels)
Brightness	400nits
Contrast Ratio	65"/75": 1200:1(typ.), 86" 4000:1(typ.)
Response Time	8ms (typ.)
Refreshing Frequency	60Hz
Viewing Angle	178° (H) / 178° (V)
Lifetime	50,000 hrs
Color Gamut(X% NTSC)	72%
Display Colors	1.07B(10bit)

System

CPU	Architecture - ARM A73(4) +A53(4) Working Frequency - 2.2GHz + 2.0GHz
GPU	MaliG52
RAM	8GB
ROM	128GB
OS	Android 13.0
Language	Chinese, English, Polish, German, French, Italian, Spanish, Finnish, Norwegian, Swedish, Thai, Indonesian, Japanese

Power

Power Requirements	AC 100 V ~ 240 V, 50/60 Hz
Power Consumption Without OPS	65":240W max. 75":350W max. 86":430W max.
Standby Consumption	<0.5W
Built In Speaker	2x15W+20W
OPS Power	DC 18V/5A

Connectivity

Wi-Fi	IEEE 802.11a/b/g/n/ac/ax(2.4G and 5G) IEEE 802.11a/b/g/n/ac(2.4G and 5G)
Bluetooth	BT5.1
NFC	Yes
Camera	No
Input	HDMI (2.0) IN x3 OPS (Optional) x1 LAN x1 (1000baseT R) USB3.0 x3 Type-C x1 (Support PD 65W) Touch x1 Audio In x1 RS-232 In x1(RJ45)
Output	RS232 OUT x1 (RJ45) HDMI Out x1 S/PDIF Out x1 Audio Out x1

Certification

Standard Certification	CB/CE/ERP/South Africa Efficiency/cTU-Vus/CEC/FCC/ICASA/Energy Star
------------------------	---

Product specifications may vary per region, and specifications are subject to change. This material may include corporate names and trademarks of third parties which are the properties of the third parties respectively.

Learn More: [www.hisense-b2b.com](http://www.hisense-b2b.com) | Contact Us: [sales@hisense-b2b.com](mailto:sales@hisense-b2b.com)

LinkedIn: @Hisense B2B Europe | @Hisense B2B USA | @Hisense B2B MENA | @Hisense B2B Indonesia | @Hisense B2B South Africa

Touch

Sensing Type	Infrared Touch Frame
Surface Protection	Anti-Glare Glass
Infrared Touch	≤20 points
Touch Accuracy	90%(±1mm)
Theory Clicks	Unlimited
Minimum Touch Object	≥2mm
Writing Height	<1.5mm (Support Four-Level Recognition)
Windows 10/8/7,Android	Multi Touch

Dimensions

65" 1488<sup>W</sup> x 899.5<sup>H</sup> x 122<sup>D</sup> mm / 58.6 x 35.4 x 4.8 inch  
34.5 kg / 76.07 lbs

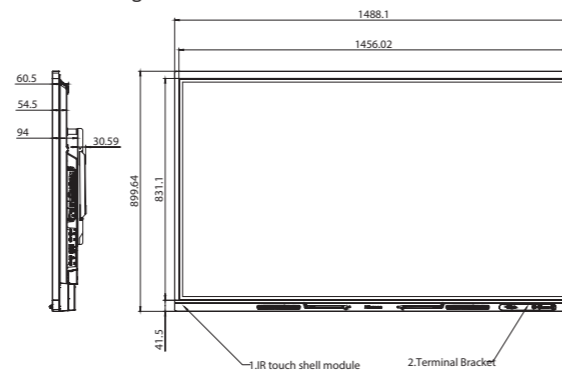

75" 1710<sup>W</sup> x 1025.5<sup>H</sup> x 126<sup>D</sup> mm / 67.3 x 40.4 x 5 inch  
45.3 kg / 99.89 lbs

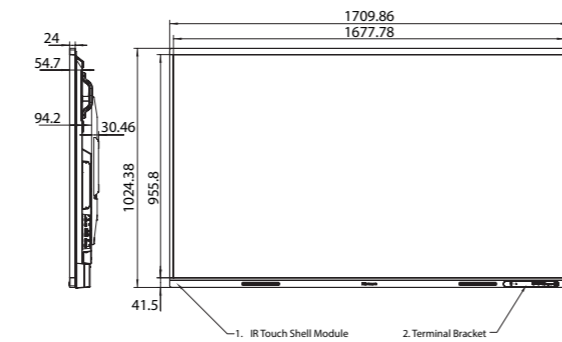

86" 1955<sup>W</sup> x 1162.5<sup>H</sup> x 126<sup>D</sup> mm / 77 x 45.8 x 5 inch  
58 kg / 127.89 lbs

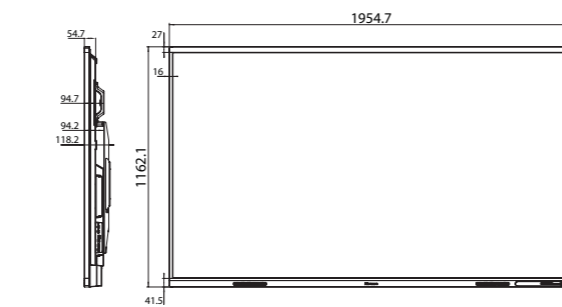

Interactive Display Panel

Models	65MR6DE-E / 75MR6DE-E / 86MR6DE -E
Backlight Type	D-LED
Resolution	3840x2160(pixels)
Brightness	350nits
Contrast Ratio	65"/75": 1200:1(typ.), 86" 4000:1(typ.)
Response Time	8ms (typ.)
Refreshing Frequency	60Hz
Viewing Angle	178° (H) / 178° (V)
Lifetime	50,000 hrs (min.)
Color Gamut(X% NTSC)	72%
Display Colors	1.07B(10bit)

System

CPU	Architecture - ARM A73(4) +A53(4) Working Frequency - 2.2GHz + 2.0GHz
GPU	MaliG52
RAM	4GB
ROM	64GB
OS	Android 13.0
Language	Chinese, English, Polish, German, French, Italian, Spanish, Finnish, Norwegian, Swedish, Thai, Indonesian, Japanese

Power

Power Requirements	AC 100 V ~ 240 V, 50/60 Hz
Power Consumption Without OPS	65":240W max. 75":350W max. 86":430W max.
Standby Consumption	<0.5W
Built In Speaker	2x15W+20W
OPS Power	DC 12V/5A

Connectivity

Wi-Fi	IEEE 802.11a/b/g/n/ac/ax(2.4G and 5G) IEEE 802.11a/b/g/n/ac(2.4G and 5G)
Bluetooth	BT5.1
NFC	Yes
Camera	No
Input	HDMI (2.0) IN x3 OPS (Optional) x1 LAN x1 (1000baseT R) USB3.0 x3 Type-C x1 (Support PD 65W) Touch x1 Audio In x1 RS-232 In x1(RJ45)
Output	RS232 OUT x1 (RJ45) HDMI Out x1 S/PDIF Out x1 Audio Out x1

Certification

Standard Certification	CB/CE/ERP/South Africa Efficiency/cTU-Vus/CEC/FCC/ICASA/Energy Star
------------------------	---

Product specifications may vary per region, and specifications are subject to change. This material may include corporate names and trademarks of third parties which are the properties of the third parties respectively.

Learn More: [www.hisense-b2b.com](http://www.hisense-b2b.com) | Contact Us: [sales@hisense-b2b.com](mailto:sales@hisense-b2b.com)

LinkedIn: @Hisense B2B Europe | @Hisense B2B USA | @Hisense B2B MENA | @Hisense B2B Indonesia | @Hisense B2B South Africa



Touch

Sensing Type	Infrared Touch Frame
Surface Protection	Anti-Glare Glass
Infrared Touch	≤20 points
Touch Accuracy	90%(±1mm)
Theory Clicks	Unlimited
Minimum Touch Object	≥2mm
Writing Height	<1.5mm (Support Four-Level Recognition)
Windows 10/8/7,Android	Multi Touch

Dimensions

65" 1488<sup>W</sup> x 899.5<sup>H</sup> x 122<sup>D</sup> mm / 58.6 x 35.4 x 4.8 inch  
34.5 kg / 76.07 lbs

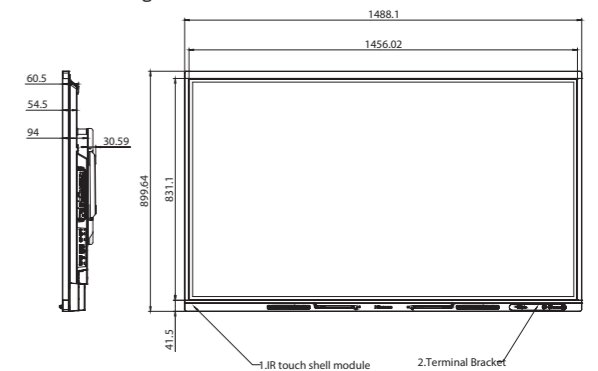

75" 1710<sup>W</sup> x 1025.5<sup>H</sup> x 126<sup>D</sup> mm / 67.3 x 40.4 x 5 inch  
45.3 kg / 99.89 lbs

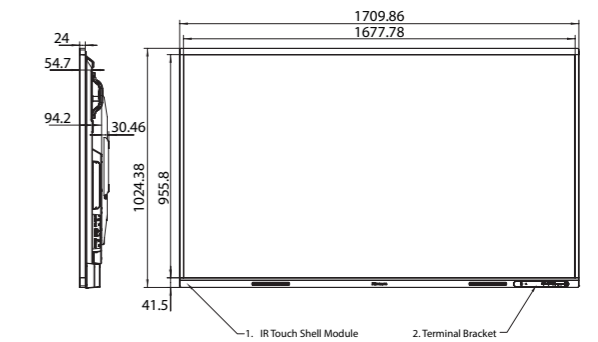

86" 1955<sup>W</sup> x 1162.5<sup>H</sup> x 126<sup>D</sup> mm / 77 x 45.8 x 5 inch  
58 kg / 127.89 lbs

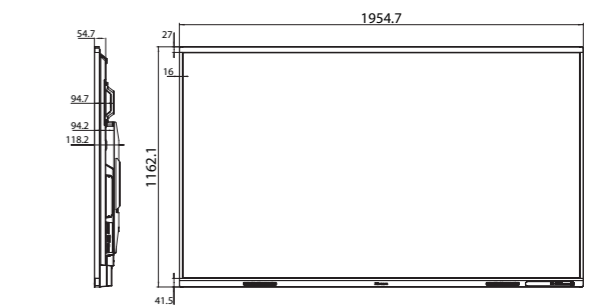

**Hisense** | COMMERCIAL  
DISPLAY